

AGGLOMERATION IN ERAMET

Agglomeration Seminar NyKoSi

22 - 23 November, 2016
Leif Hunsbedt / Peter Cowx



ERAMET

ALLOYS, ORES & PEOPLE.

PYROMETALLURGICAL CONSULTANCY
TECHNICAL ASSISTANCE TO THE SMELTING INDUSTRY



CONTENT

1. Short information on Eramet
2. Background for Mn-ore agglomeration project - «the NewERA project»
3. Agglomeration options for Mn-ore fines and by-products
4. Mn-ore fines agglomeration test work
5. Conclusions

“ERAMET IS A FRENCH MINING AND METALLURGICAL GROUP AND A WORLD LEADER IN ITS BUSINESS”

Alloys powder and transformation plants

Manganese alloys and Tizir titanium dioxide / pig iron

The Norwegian plants are the main part of Eramets Mn-alloy activity

Manganese chemicals and recycling

TiZir – Grande Côte (Senegal) ilmenite and zircon mine

Manganese mine
Manganese alloys and metal plants

Maboumine project - niobium and rare earths (under study)

Manganese mine project (under study)

High purity nickel and alloys melting and transformation plants

Manganese alloys plant (China)

Weda Bay nickel project (Indonesia) – (under study)

SLN-Nickel mines and ferronickel plant (New Caledonia)



A world leading producer of Manganese alloys

- The Porsgrunn and Sauda plants - from Elkem in 1999
- The Kvinesdal plant -from Tinfos in 2008
- Eramet Norway 2015:
 - 517 FTE
 - 4,7 bill NOK in turnover
 - COI ~14%
 - Sales volumes; 493 KT of which refined: ~ 60%
 - El. consumption: 2 TWh
 - CO2 emissions: 800 Ktons
- Capex spendings since 2000:
 - Ca 2,000 mill NOK of which ca 30% = HES



Eramet Norway Sauda



Eramet Norway Porsgrunn



Eramet Norway Kvinesdal

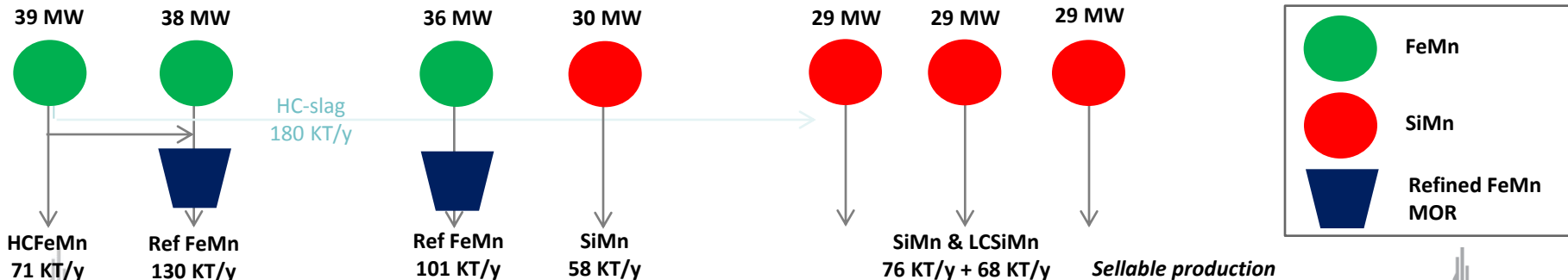

THE OBJECTIVES OF THE ERAMET NewERA PROJECT

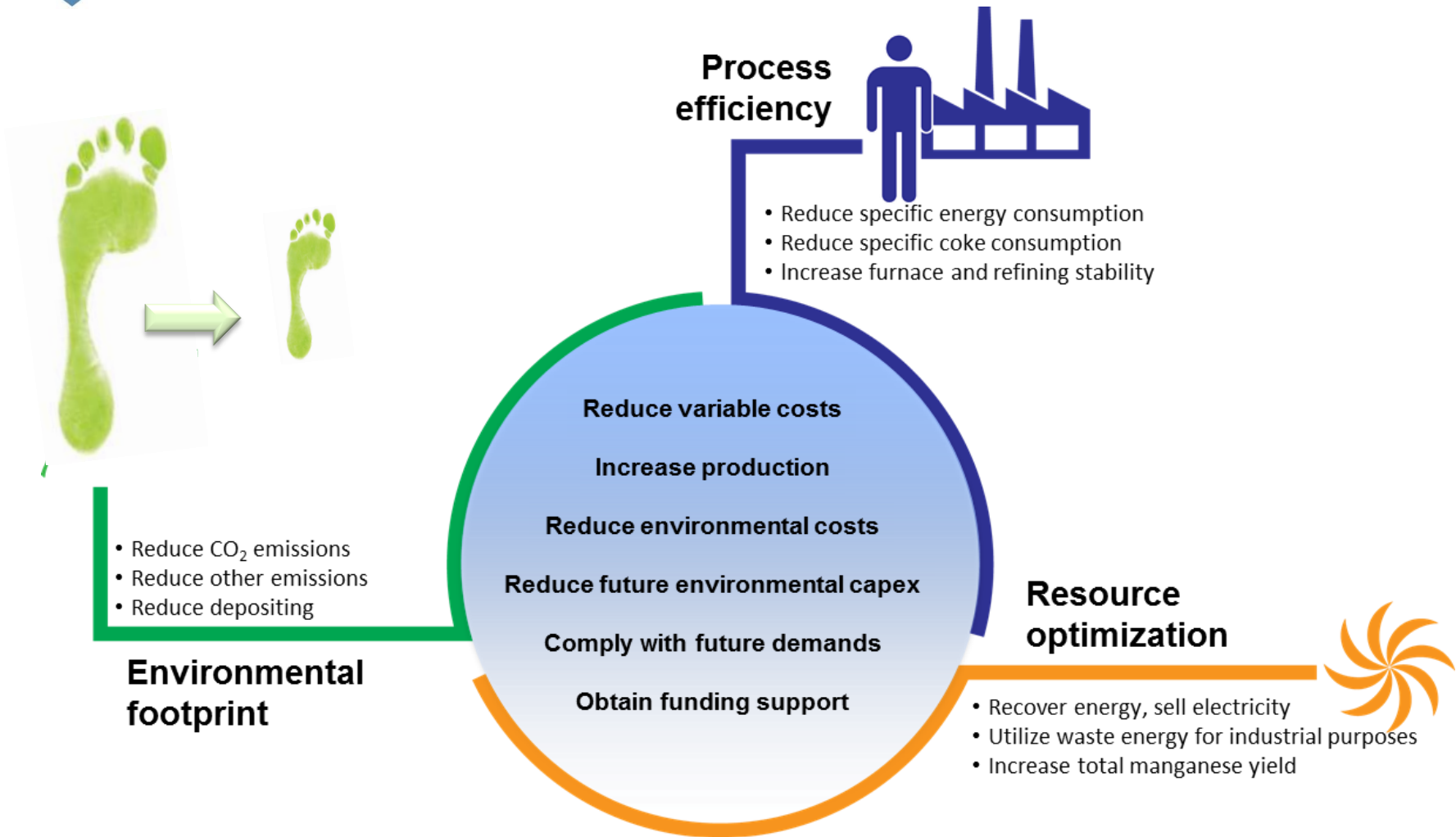

- ❑ **Energy recovery:** Gas engines to combust the furnace gases that are currently flared. Engines will produce electricity, hot water for district heating and exhaust gases for the dryer.
- ❑ **Ore drying:** A rotary dryer using the hot combusted gas from the gas engines to dry the ore.
- ❑ **Screening:** Dried ore will be screened at 3mm. The dried 3-80 mm lumps will be fed directly to the HCFeMn furnace. Fines below 3 mm together with Mn-containing filter dusts and sludges will be agglomerated.
- ❑ **Agglomeration:** Roll-press, vibration-compaction or “tableting” are considered to agglomerate the ore fines and dusts.
- ❑ **Waste-to-value:** Agglomerate Mn by-product together with Mn-ore fines and recycle to HCFeMn or SiMn furnaces.



WHY DRY AND SCREEN THE ORE?

Reasons:

- ❑ Eramet wants to improve the permeability of the furnace charge in order to increase the consumption of the Gabonese ore to benefit from the inherent properties of this ore

Potential benefits:

- ❑ Increase pre-reduction in the furnace.
- ❑ Decrease specific electrical energy.
- ❑ Decrease specific carbon consumption.
- ❑ Increase furnace operating stability and time at full load.
- ❑ Increase production.
- ❑ Reduce CO₂ footprint.



The agglomeration technique chosen will be dependent on:

- Thermodynamic properties of the agglomerate.
- Raw materials particle size.
- Agglomerate size required.
- Binder.
- Cold and hot strength.
- Reactivity.
- Porosity.
- Capacity.
- Cost.
- Industrially demonstrated on Mn-ores.

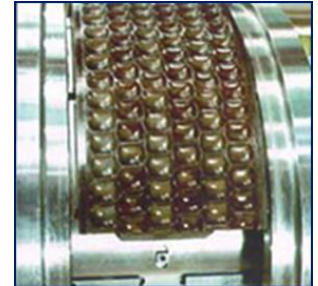

MATERIALS TO BE AGGLOMERATED

materials	Particle size	blend	moisture
Ore fines	0-3mm	30%	<2%
Ore dryer filter dust	<50mm	45%	<2%
Sludge	<50mm	10%	40%
Filter dust	<50mm	3%	<2%
Metallic fines	0-1mm	15%	<2%

The «ore filter dust» is the ore fines captured in the filter after the rotary dryer.

THERMODYNAMIC PROPERTIES

Reduction curve as function of temperature based on weight loss

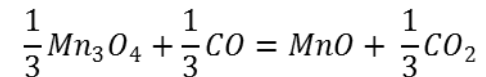
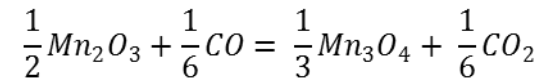
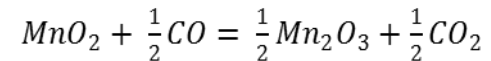
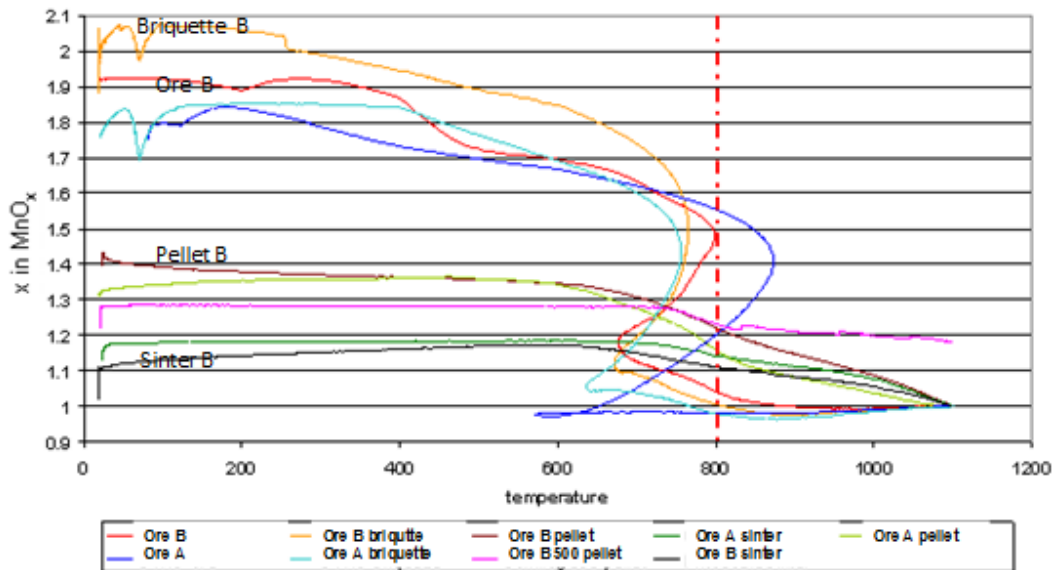

- ❑ Cold bonded agglomerates containing Gabonese ore are highly oxidised – MnO₂.
- ❑ Hot bonded Gabonese sinter and indurated pellets have a lower degree of oxidation as the MnO₂ is reduced to lower oxides during the sintering / induration process.
- ❑ There will be an energy benefit in the furnace from exothermic pre-reduction of highly oxidised ore briquettes compared to sinter and pellets.
- ❑ **Therefore from an energy perspective it is preferable to smelt cold-bonded agglomerates rather than hot-bonded sinter or pellets.**

- ❑ Different agglomeration techniques require different raw materials sizing:
 - Sintering: 1-10mm
 - Pelletising: Max 0,2mm
 - Briquetting: 0-6mm
 - Extrusion: 0-6mm
 - Eirich mixer: <1mm

- For briquetting, a combination of fine and course particles will give a stronger briguette. The correct blend can be achieved by screening, extra crushing or blending in other materials. Too much coarse material can weaken the briquette and increase machine wear.

- **For pelletising, the <3mm Mn-ore would have to be milled. This increases the agglomeration cost and and therefore pelletising is eliminated.**

PARTICLE SIZE DISTRIBUTION – AGGLOMERATE STRENGTH

- Adherence to an ideal particle size distribution curve, (eg. Fuller curve), gives the maximum compaction, cold and hot compressive strength in agglomerates.

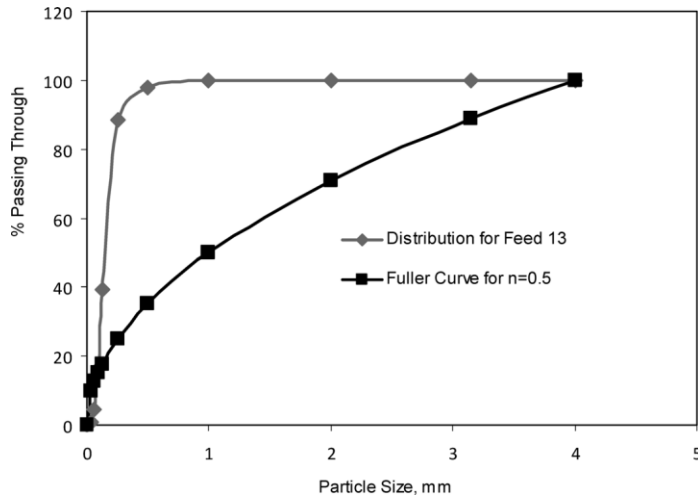

Cr-ore particle size distribution

$$P_x = [d_x/d_{max}]^n \cdot 100$$

Where

p_x = % passing square aperture size d_x

d_{max} = maximum particle size, mm

$n = 0.5$, grading co-efficient for Fuller's curve

- The coefficient of uniformity (CU) indicates the deviation from the Fuller curve, where D_{60} and D_{10} are the screen apertures for which 60% and 10% of the sample passes through, respectively.

$$CU = \frac{D_{60}}{D_{10}}$$

The CU for the 'ideal' Fuller curve is 36, but satisfactory agglomerates are made is $CU \Rightarrow 5$

The agglomerate size is a compromise:

- Agglomerates, ore and coke should have a similar size range to avoid segregation.
- Large agglomerates are more susceptible to thermal decrepitation than small particles.
- Small agglomerates will most likely have a higher CO-gas reactivity (shrinking core model).
- Very small agglomerates may decrease the furnace charge permeability.
- The agglomerate should be $<1/3^{\text{rd}}$ the diameter of the charging chutes to prevent blockages.
- Larger agglomerates allow a higher machine productivity.
- Larger agglomerates may experience a smaller compaction pressure at their centre which may result in a more fragile agglomerate.
- The wear on roll press equipment will be greater with smaller briquettes.
- An agglomerate size between 5mm and 60mm is recommended.**

AGGLOMERATE POROSITY

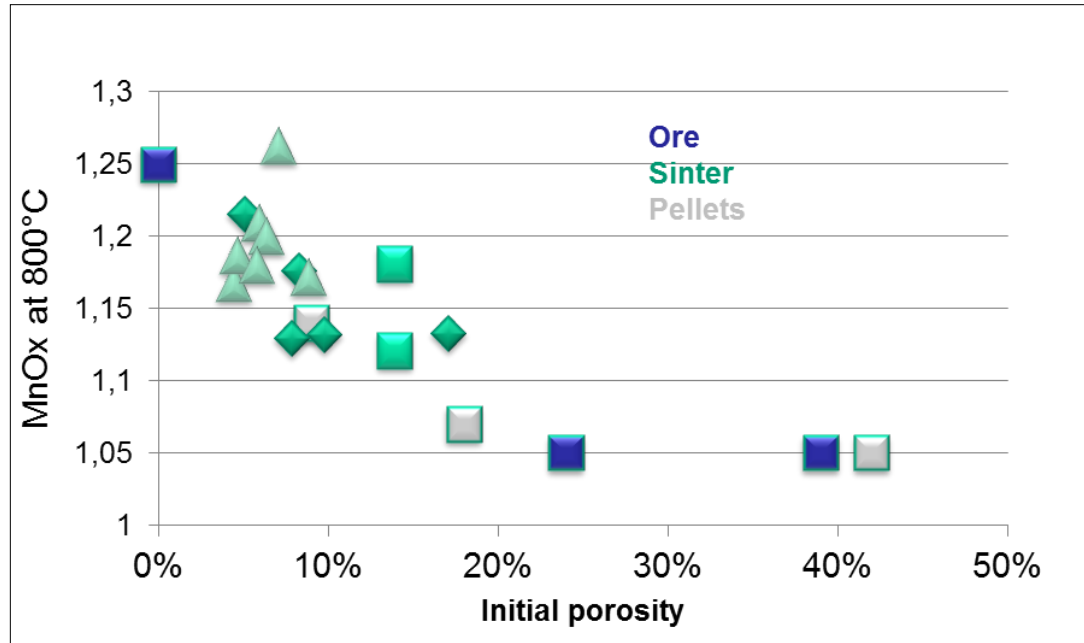

Ref. M. Tangstad

- The degree of pre-reduction tends to increase as the porosity in the ore or agglomerate increases.
- An agglomerate with a high porosity is desirable - provided it is strong.**

WHAT BINDER TO USE?

Binder criteria:

- Short curing / hardening time without post heat treatment
- Agglomerate cold and hot strength – transport to the furnace
- Minimum of unwanted components (slag formation, volatile hydrocarbons / sticky deposits)
- Easy to handle.
- Low cost.

Organic binders:

- Molasses / lime, lignosulphonate, Carboxymethyl cellulose (CMC):
- ~24 hours hardening time indoors before can be transported.
- Satisfactory cold and hot strength
- No slag production

Cement (OPC):

- Maximum strength is obtained after 2-4 weeks stored under ambient conditions.
- Cement contributes to slag formation and consumes energy
- Cement bonded agglomerates tend to break-up on heating.

Bentonite:

- Low cold strength

Organic binder are preferred

AGGLOMERATION IN ERAMET

Technique	material	binder	plant
Sintering (moving grate)	Mn ore fines	none	Eramet Gabon Eramet China
Green pelletising	Filter dust from oxygen refining of HCFeMn	10-12% cement	Eramet Sauda, Norway
Indurated pellets	Ilmenite	Bentonite	Tizir, Norway
Vibration / compaction	Mn ore fines, filter dusts	10-12% cement	Aaltvedt, Norway
Roll press briquetting	Mn ore fines	~5% molasses / lime, lignosuphonat, organics	Euroagglo NewERA test work, France
Eirich mixer	Venturi sludge	blended with filter dusts	Eirich mixer test work, Germany, Norway
«Tablet» machine	Mn-ore fines	none	Eurotab Go-4-0 test work France



Typical sinter mix consisted of 1-10mm Mn-ore fines, <6mm coke fines, return sinter fines and flux additives. Materials are pelletised in a rotating drum where moisture additions are made. The raw sinter mix is then layered on the hearth layer to a total depth of about 500mm. Ignition of the coke in the mix is by horizontal burners. Suction is applied beneath the grate to draw in air and propagate the ignition front through the bed. The sinter is discharged from the moving grate into a cooler, then crushed to <75mm.

❑ Advantages:

- Industrial operation with Mn-ores
- Porous, strong product
- Waste materials can be recycled

❑ Disadvantages

- Large capacity
- High Capex
- Lost advantage of exothermic reduction of Mn-ore in the furnace

Hot bonding not considered for agglomerating NewERA Mn-ores because of size/capacity and loss of exothermic effect in furnace

ROLL PRESS BRIQUETTING



- ❑ Cold bonding process where a mixture of fines and a binder is compressed in a rotary die to form a product with uniform size and shape.
- ❑ **Advantages:**
 - Takes advantage of exothermic pre-reduction of MnO_2 in the furnace
 - Molasses /lime, lignosulphonate and organics can be used as binders.
 - 0,1-6mm ore particles size, no fine grinding is required.
 - Different agglomerate sizes possible.
 - Short hardening time with molasses or lignosulphonate.
 - No slag formation with molasses, lignosulphonate, organic binders.
 - Strong product that can be easily transported.
 - Automated process that does not require continuous supervision.
 - In industrial operation with Mn-ore fines, chromite fines, steelmill wastes.
 - High capacity
- ❑ **Disadvantages:**
 - Strength of briquettes with organic binder over long time?
 - Break down products of organic binder in a sealed furnace?
- ❑ **Opportunities**
 - Recycle by-products together with the Mn-ore fines.
 - Composite briquettes of manganese ore fines and coal /coke may prove beneficial due to the exothermic reactions taking place between the higher manganese oxides and volatiles from the coal during heating

VIBRATION-COMPACTION



- ❑ Fines plus cement binder are vibrated then compacted in a multi-cell mold. The green briquettes are then dried and cured for several days. Developed from cement block making process.

- ❑ Advantages:

- Takes advantage of exothermic pre-reduction of MnO_2 in the furnace.
- 0,1-6mm ore particles size, no fine grinding is required.
- Different agglomerate sizes.
- Strong product
- Automated process that does not require continuous supervision.
- High capacity.
- In industrial operation with Mn-ore fines, steelmill wastes, ...

- ❑ Disadvantages:

- Long hardening time to peak strength with cement binder.
- Temperate hardening room required ?
- Slag formation with cement binder.
- Cement binder tends to break up on heating

- ❑ Opportunities:

- Use lignosuphonate or molasses as binder?
- Recycle by-products together with the Mn-ore fines.
- Composite briquettes of Mn-ore fines and coal /coke

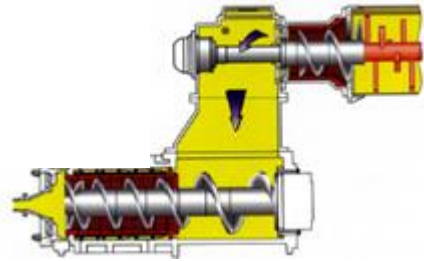

- The machine consists of a mixer, a vacuum chamber and a screw extruder. Ore fines, dusts and sludges are blended with cement binder and water and compacted, de-aerated by vacuum and forced through a die to make long “sausages”.
- Advantages:**
 - Takes advantage of exothermic pre-reduction of MnO_2 in the furnace
 - Strong green extrudate due to higher mixture density / vacuum de-aeration.
 - Low binder consumption?
 - Low capital cost of equipment.
 - Ability to make briquettes of different sizes.
 - High capacity (15-115mt/h).
 - Demonstrated on Mn-ores.
- Disadvantages:**
 - Cement binder, slag formation, higher energy consumption.
 - Extuder wear.
- Opportunities:**
 - Can use wet sludges direct into machine.

HIGH INTENSITY MIXER (EIRICH)

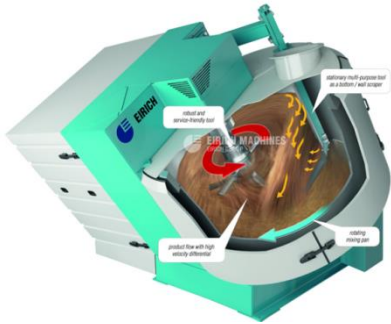

❑ Fine material is fed into the inclined rotating mixing pan. The combination of rotating pan and fast rotating rotors generate nuclei. The rotation speed is then reduced to increase the size of the granules.

❑ Advantages:

- Takes advantage of exothermic pre-reduction of MnO_2 in the furnace
- No binder consumption.
- OK green strength of granules (>2kg.f/ pellet).
- Drying improves strength. But may increase dusting.
- Low capital cost of equipment.
- Low operating cost.

❑ Disadvantages:

- Can only agglomerate <0,5mm particles?
- Transport; some dusting and sticking to silo walls
- Some curing time / drying is probably needed improve green strength.
- Relatively small granules size , 1-10mm.
- Not commercially demonstrated on Mn-ores

❑ Opportunities.

- Mixer can be used as a pre-treatment step before roll-press or vibration-compaction briquetting.
- Testwork performed with venturi sludge and filter dusts at Eramet Kvinesdal

Tableting: this technology is not used in the mining and metallurgical industry, but has been developed for the food and pharmaceutical industries. It offers the possibility of agglomerating without using a binder.

Advantages:

- No /low binder consumption.
- Takes advantage of exothermic pre-reduction of MnO₂ in the furnace

Disadvantages:

- High capital cost.
- Small capacity.
- Not demonstrated on Mn-ores.

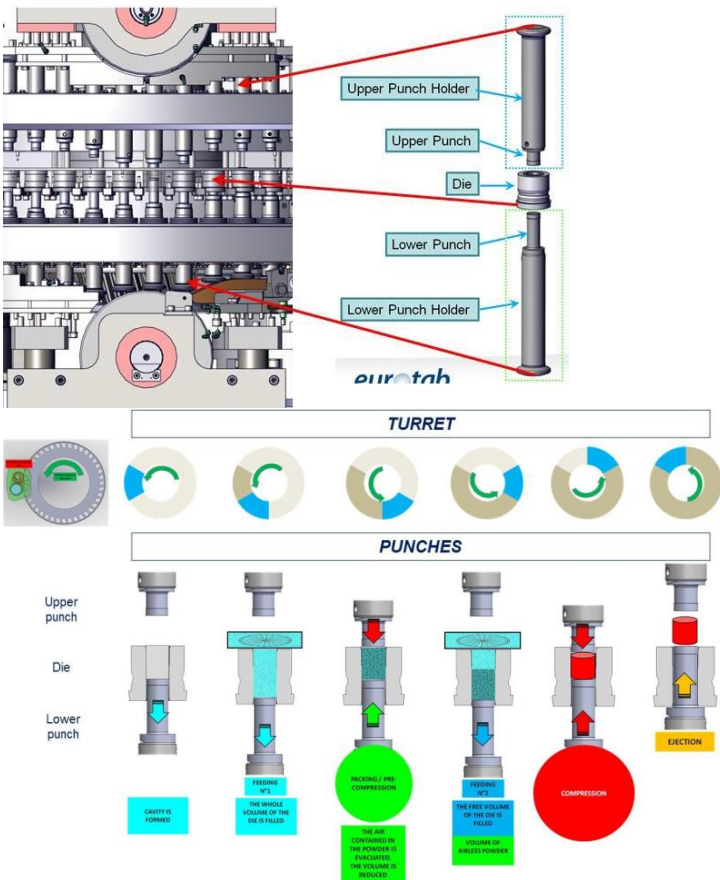

CHOICE OF AGGLOMERATION TECHNIQUE FOR Mn-ORE FINES

Technology	sinter	Indurated pellets	Roll press briquetting	Vibration compaction	Extrusion	High intensity mixer	tablet
Equipment capacity	large	medium	medium	medium	medium	small units	Small units
Capital cost	high	high	medium	medium	medium	low	high
Operating cost	medium	medium	Low.	low	medium	low	low
Energy cost	high	high	low	low	low	low	medium
Complexity	medium	high	low	medium	low	low	high
Ore particle size	<5mm	<45 μ	<3mm	<5mm	<5mm	<3mm	<5mm
Product size, mm	5-80mm	10-15mm	50mm	75mm	25mm	<5mm	<10mm
Feed moisture, %	<5%	<5%	<3%	<5%	<25%	<5%	<5%
Binder	ceramic	bentonite,	Molasses, ligno	Cement	Gel agent	Cement, bentonite ?	none
Post treatment	None	none	Drying / curing	Drying / curing	Drying / curing	Drying / curing	none
Cold strength	medium	high	high	high	medium?	low?	high
Hot strength	High	high	High	Medium	?	?	?
Porosity	High	medium	medium	medium	medium	high	low
CO /MnOx Reactivity	low	medium	high	high	high?	high	high?
Smelting energy	high	high	low	medium	low	low	low
Industrial demonstrated	yes	no	no	yes	no	no	no

TEST WORK ON Mn-ORE FINES AND BY-PRODUCTS

Euroagallo facility

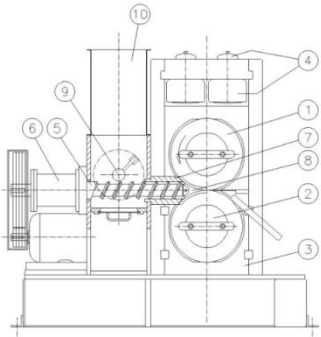

Examine:

- Briquetting properties of Mn-ore fines and by-products
- Different binders: molasses, lignosulphonate, Peridur, bentonite, resin
- Binder addition rates: 3 rate, recommended + / -
- Curing time:
- Cold strength
- (Hot strength)
- (CO reactivity)

	molasses			lignosulphonate									
	1	2	3	4	5	6	7	8	9	10	11	12	13
% lime	2	4	3					3	3	3			
%molasses	4	8	6					6	6	6			
% Lignosulphonat				2	4	3							
% Bentonite											1		
%Peridur												0,5	
% Euroagallo resin													1,5

- ❑ **Briquetting technique:** Roll-press briquetting produced acceptable briquettes.
- ❑ **Mix:** Possible to make strong briquettes with Mn-ore fines and by-products combined.
- ❑ **Cold strength:** Lignosulphonate and molasses /lime gave briquettes with a cold crushing strength of >150kg.f
- ❑ **Binder:** preferred binder: lignosulphonate => molasses => resin
- ❑ **Binder amount:**
 - Lignosulfonate: a minimum of 4% lignosulfonate is needed, curing time 24h
 - Lime and molasse: a minimum of 3% lime and 6% molasse , curing time of 24h
 - Strength began to deteriorate after longer storage.
 - Optimisation tests are required resin binder and Peridur
- ❑ **Ore particle size, <3mm of <5mm.** Does not seem to have a great influence on mechanical properties of briquettes.
- ❑ **Hot strength:** briquettes generate less fines on heating than Gabonese ore.
- ❑ **CO reactivity:** Briquettes are as reactive as Gabonese ore.

The presented work on agglomeration and particularly «waste-to-value» was made with help from:

- ❑ Industrial partners: Eramet Norway, Eramet Research, Eramet Engineering,
- ❑ R&D partners: NTNU, Sintef, SFI.
- ❑ Technical advice: Euroagгло, Eurotab, Aaltvedt, Borregaard, Akso-Nobel.
- ❑ Financial support: Enova, EU (Go-4-0)
- ❑ Test work; Thomas By, student, NTNU.

Thanks you for your attention!

